

# CAS120M12BM2

## 1.2kV, 13 mΩ All-Silicon Carbide Half-Bridge Module

*C2M MOSFET and Z-Rec<sup>®</sup> Diode*

$V_{DS}$	1.2 kV
$E_{sw, Total} @ 120A, 150\text{ }^{\circ}C$	2.1 mJ
$R_{DS(on)}$	13 mΩ

### Features

- Ultra Low Loss
- High-Frequency Operation
- Zero Reverse Recovery Current from Diode
- Zero Turn-off Tail Current from MOSFET
- Normally-off, Fail-safe Device Operation
- Ease of Paralleling
- Copper Baseplate and Aluminum Nitride Insulator

### System Benefits

- Enables Compact and Lightweight Systems
- High Efficiency Operation
- Mitigates Over-voltage Protection
- Reduced Thermal Requirements
- Reduced System Cost

### Applications

- Induction Heating
- Solar and Wind Inverters
- DC/DC Converters
- Line Regen Drives
- Battery Chargers

**Package 62mm x 106mm x 30mm**



Part Number	Package	Marking
CAS120M12BM2	Half-Bridge Module	CAS120M12BM2

### Maximum Ratings ( $T_c = 25\text{ }^{\circ}C$ unless otherwise specified)

Symbol	Parameter	Value	Unit	Test Conditions	Notes
$V_{DSmax}$	Drain - Source Voltage	1.2	kV		
$V_{GSmax}$	Gate - Source Voltage	-10/+25	V	Absolute maximum values	
$V_{GSop}$	Gate - Source Voltage	-5/20	V	Recommended operational values	
$I_D$	Continuous MOSFET Drain Current	193	A	$V_{GS} = 20\text{ V}, T_c = 25\text{ }^{\circ}C$	Fig. 26
		138		$V_{GS} = 20\text{ V}, T_c = 90\text{ }^{\circ}C$	
$I_{D(pulse)}$	Pulsed Drain Current	480	A	Pulse width $t_p$ limited by $T_{J(max)}$	
$I_F$	Continuous Diode Forward Current	305	A	$V_{GS} = -5\text{ V}, T_c = 25\text{ }^{\circ}C$	
		195		$V_{GS} = -5\text{ V}, T_c = 90\text{ }^{\circ}C$	
$T_{Jmax}$	Junction Temperature	-40 to +150	$^{\circ}C$		
$T_c, T_{STG}$	Case and Storage Temperature Range	-40 to +125	$^{\circ}C$		
$V_{isol}$	Case Isolation Voltage	5	kV	AC, 50 Hz, 1 min	
$L_{Stray}$	Stray Inductance	15	nH	Measured between terminals 2 and 3	
$P_D$	Power Dissipation	925	W	$T_c = 25\text{ }^{\circ}C, T_J = 150\text{ }^{\circ}C$	Fig. 25



## Electrical Characteristics ( $T_c = 25^\circ\text{C}$ unless otherwise specified)

Symbol	Parameter	Min.	Typ.	Max.	Unit	Test Conditions	Note
$V_{(BR)DSS}$	Drain - Source Breakdown Voltage	1.2			kV	$V_{GS} = 0\text{ V}, I_D = 300\ \mu\text{A}$	
$V_{GS(th)}$	Gate Threshold Voltage	1.8	2.6		V	$V_{DS} = 10\text{ V}, I_D = 6\text{ mA}$	Fig. 7
$I_{DSS}$	Zero Gate Voltage Drain Current		80	300	$\mu\text{A}$	$V_{DS} = 1.2\text{ kV}, V_{GS} = 0\text{V}$	
			400	1500		$V_{DS} = 1.2\text{ kV}, V_{GS} = 0\text{V}, T_J = 150^\circ\text{C}$	
$I_{GSS}$	Gate-Source Leakage Current		1	100	nA	$V_{GS} = 20\text{ V}, V_{DS} = 0\text{V}$	
$R_{DS(on)}$	On State Resistance		13	16	m $\Omega$	$V_{GS} = 20\text{ V}, I_{DS} = 120\text{ A}$	Fig. 4, 5, 6
			23	30		$V_{GS} = 20\text{ V}, I_{DS} = 120\text{ A}, T_J = 150^\circ\text{C}$	
$g_{fs}$	Transconductance		53.8		S	$V_{DS} = 20\text{ V}, I_{DS} = 120\text{ A}$	Fig. 8
			48.5			$V_{DS} = 20\text{ V}, I_D = 120\text{ A}, T_J = 150^\circ\text{C}$	
$C_{iss}$	Input Capacitance		6.3		nF	$V_{DS} = 1\text{ kV}, f = 200\text{ kHz}, V_{AC} = 25\text{ mV}$	Fig. 16, 17
$C_{oss}$	Output Capacitance		0.88				
$C_{rss}$	Reverse Transfer Capacitance		0.037				
$E_{on}$	Turn-On Switching Energy		1.7		mJ	$V_{DD} = 600\text{ V}, V_{GS} = -5\text{V}/+20\text{V}$ $I_D = 120\text{ A}, R_{G(ext)} = 2.5\ \Omega$ Load = 142 $\mu\text{H}$ , $T_J = 150^\circ\text{C}$ Note: IEC 60747-8-4 Definitions	Fig. 22
$E_{off}$	Turn-Off Switching Energy		0.4		mJ		
$R_{G(int)}$	Internal Gate Resistance		1.8		$\Omega$	$f = 200\text{ kHz}, V_{AC} = 25\text{ mV}$	
$Q_{GS}$	Gate-Source Charge		97		nC	$V_{DD} = 800\text{ V}, V_{GS} = -5\text{V}/+20\text{V}, I_D = 120\text{ A}$ , Per JEDEC24 pg 27	Fig. 15
$Q_{GD}$	Gate-Drain Charge		118				
$Q_G$	Total Gate Charge		378				
$t_{d(on)}$	Turn-on delay time		38		ns	$V_{DD} = 600\text{V}, V_{GS} = -5/+20\text{V}, I_D = 120\text{ A}, R_{G(ext)} = 2.5\ \Omega$ , Timing relative to $V_{DS}$ Note: IEC 60747-8-4, pg 83 Inductive load	Fig. 24
$t_r$	Rise Time		34		ns		
$t_{d(off)}$	Turn-off delay time		70		ns		
$t_f$	Fall Time		22		ns		
$V_{SD}$	Diode Forward Voltage		1.5	1.8	V	$I_F = 120\text{ A}, V_{GS} = 0$	Fig. 10
			1.9	2.4		$I_F = 120\text{ A}, T_J = 150^\circ\text{C}, V_{GS} = 0$	Fig. 11
$Q_C$	Total Capacitive Charge		1.1		$\mu\text{C}$	$I_{SD} = 120\text{A}, V_{DS} = 600\text{ V}, T_J = 25^\circ\text{C}, di_{SD}/dt = 3\text{ kA}/\mu\text{s}, V_{GS} = -5\text{ V}$	

## Thermal Characteristics

Symbol	Parameter	Min.	Typ.	Max.	Unit	Test Conditions	Note
$R_{thJCM}$	Thermal Resistance Junction-to-Case for MOSFET		0.125	0.135	$^\circ\text{C}/\text{W}$		Fig. 27
$R_{thJCD}$	Thermal Resistance Junction-to-Case for Diode		0.108	0.115			Fig. 28

## Additional Module Data

Symbol	Parameter	Max.	Unit	Test Condition
W	Weight	290	g	
M	Mounting Torque	5	Nm	To heatsink and terminals
	Clearance Distance	9	mm	Terminal to terminal
	Creepage Distance	30	mm	Terminal to terminal
		40	mm	Terminal to baseplate

# Typical Performance

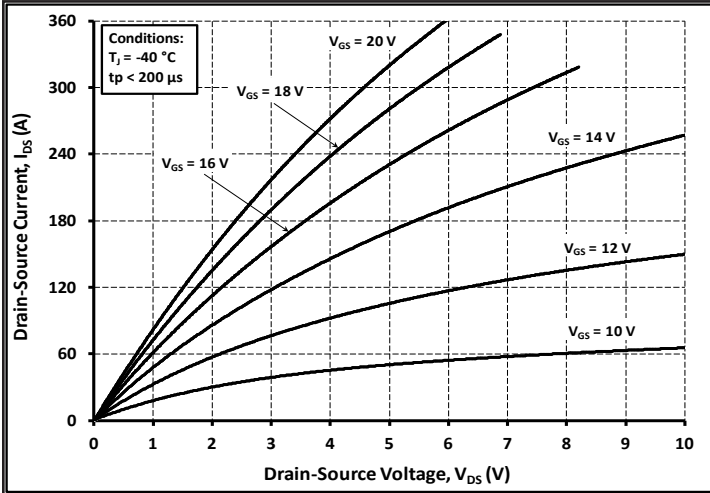

Figure 1. Output Characteristics  $T_j = -40\text{ }^\circ\text{C}$

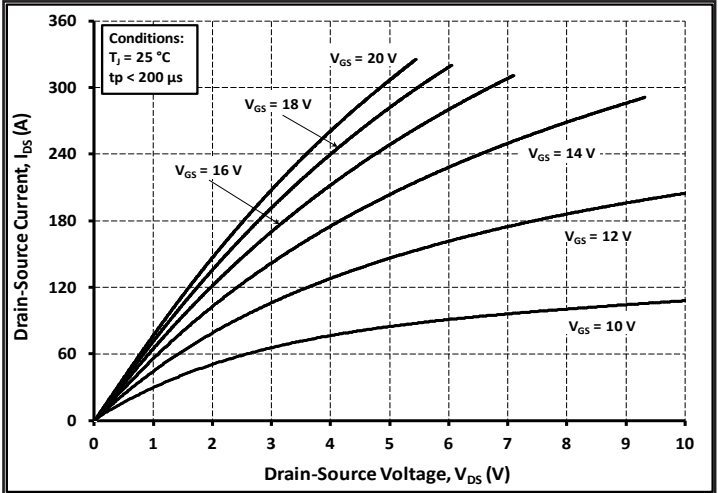

Figure 2. Output Characteristics  $T_j = 25\text{ }^\circ\text{C}$

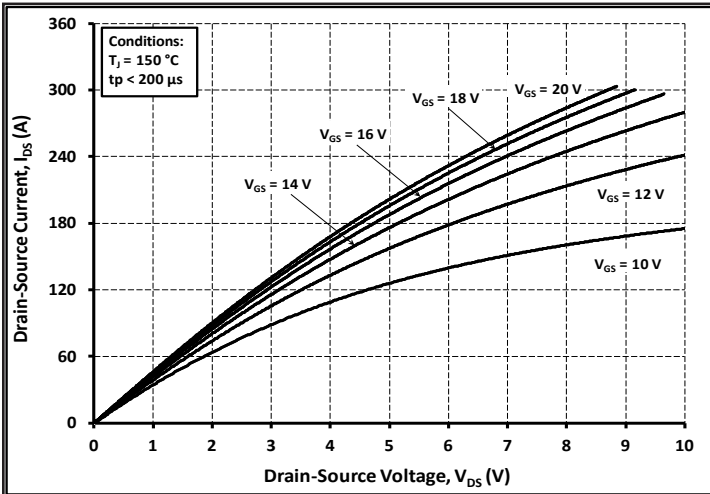

Figure 3. Output Characteristics  $T_j = 150\text{ }^\circ\text{C}$

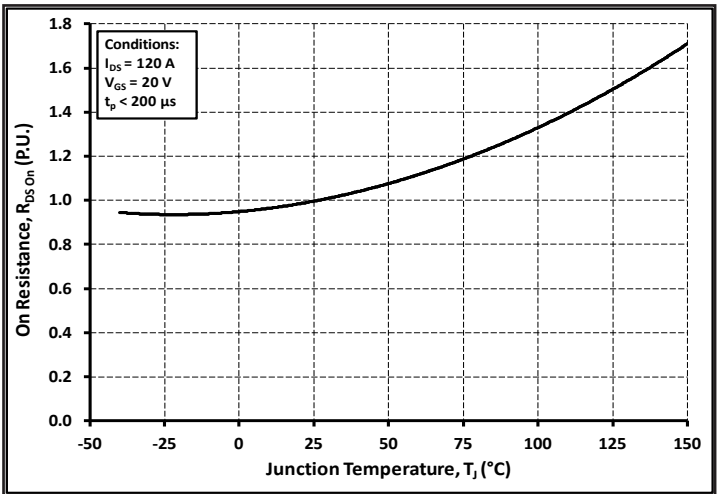

Figure 4. Normalized On-Resistance vs. Temperature

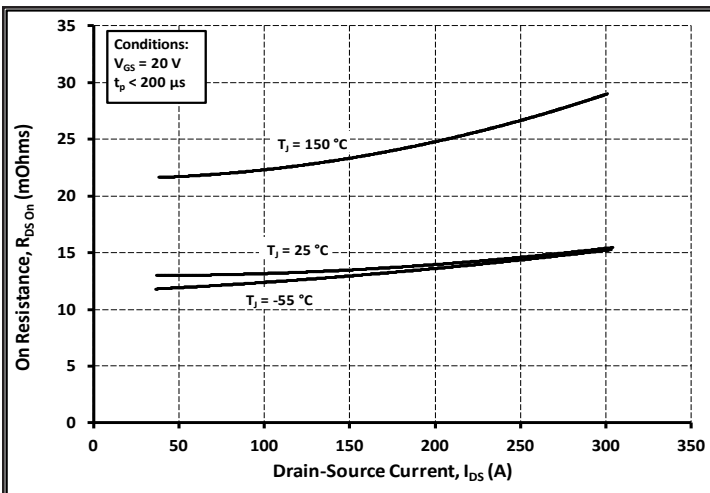

Figure 5. On-Resistance vs. Drain Current For Various Temperatures

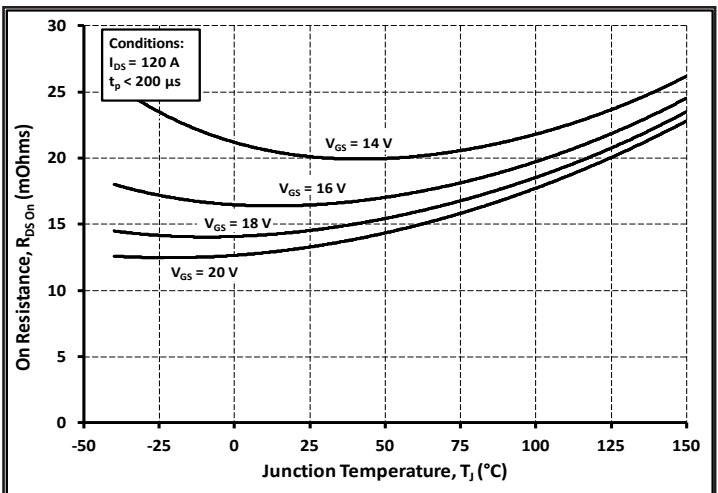

Figure 6. On-Resistance vs. Temperature For Various Gate-Source Voltage

# Typical Performance

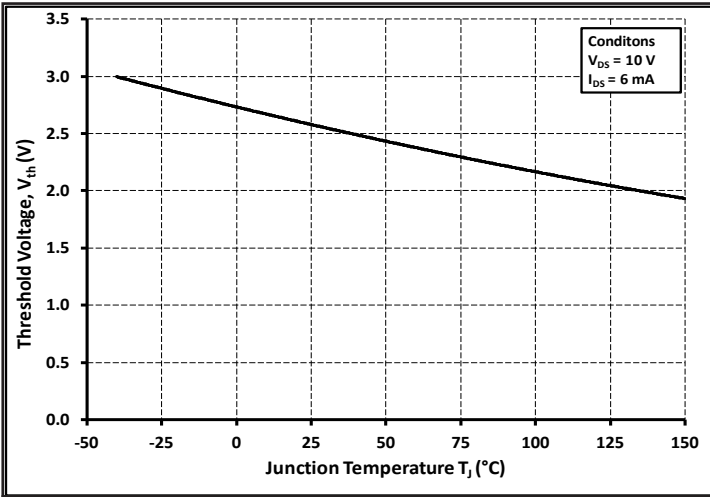

Figure 7. Threshold Voltage vs. Temperature

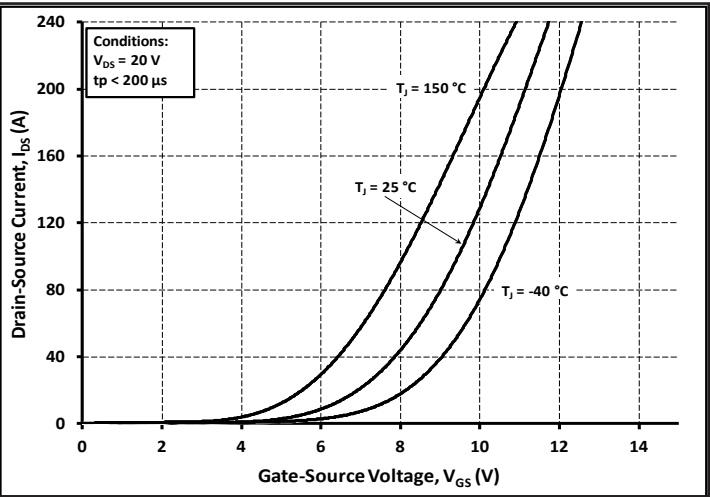

Figure 8. Transfer Characteristic for Various Junction Temperatures

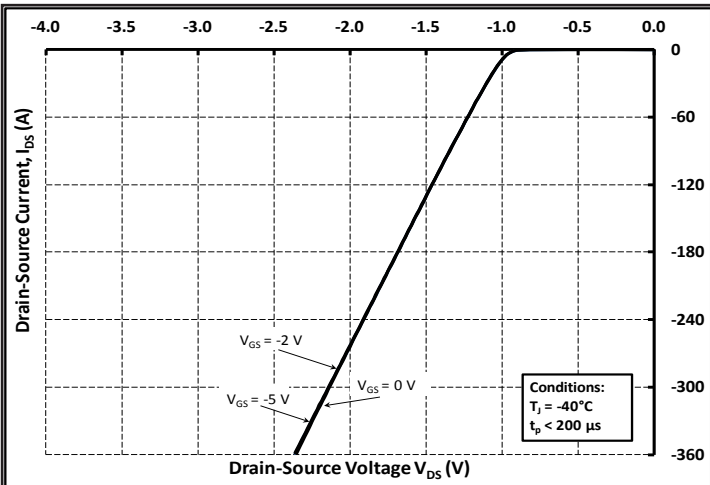

Figure 9. Diode Characteristic at -40 °C

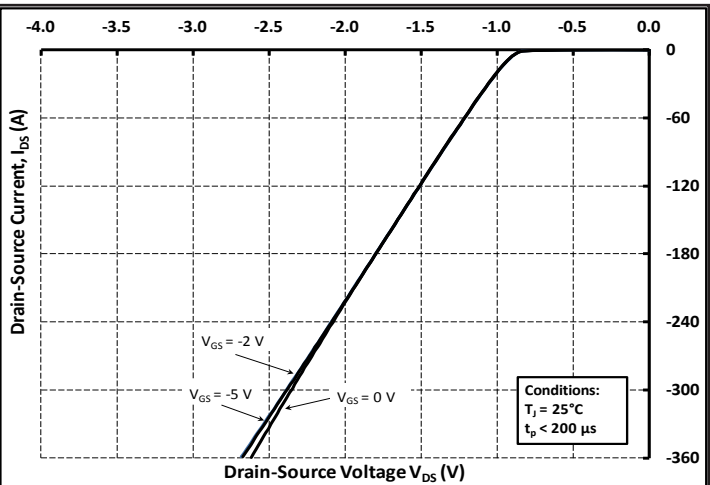

Figure 10. Diode Characteristic at 25 °C

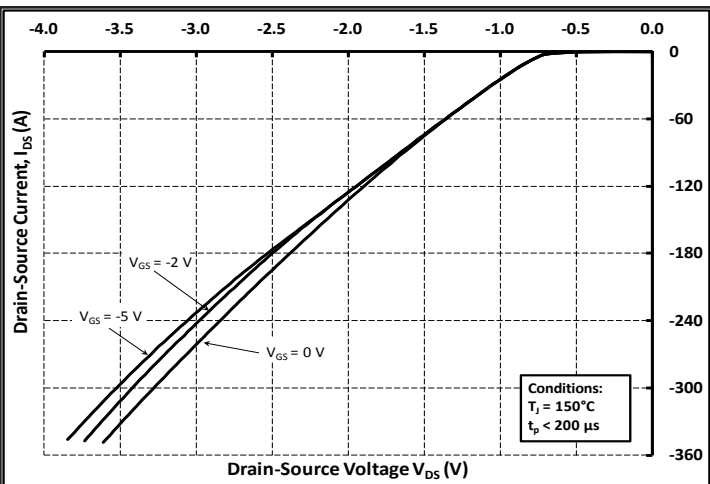

Figure 11. Diode Characteristic at 150 °C

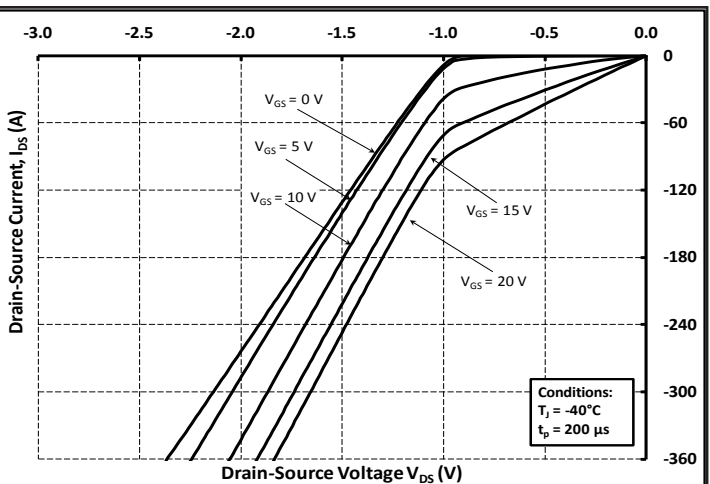

Figure 12. 3<sup>rd</sup> Quadrant Characteristic at -40 °C

# Typical Performance

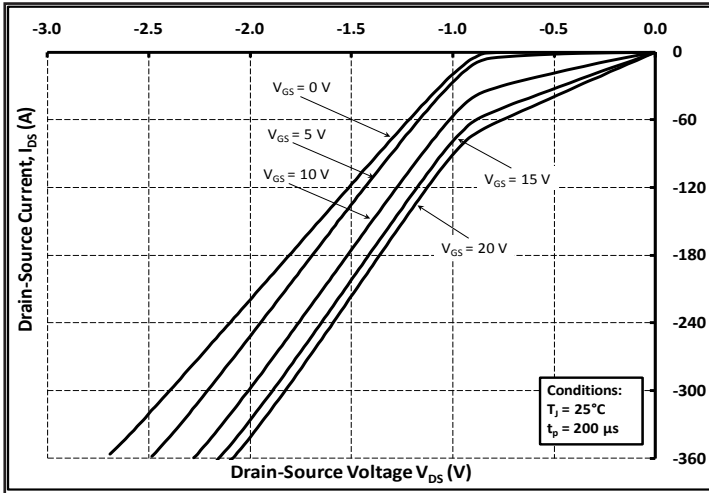

Figure 13. 3<sup>rd</sup> Quadrant Characteristic at 25 °C

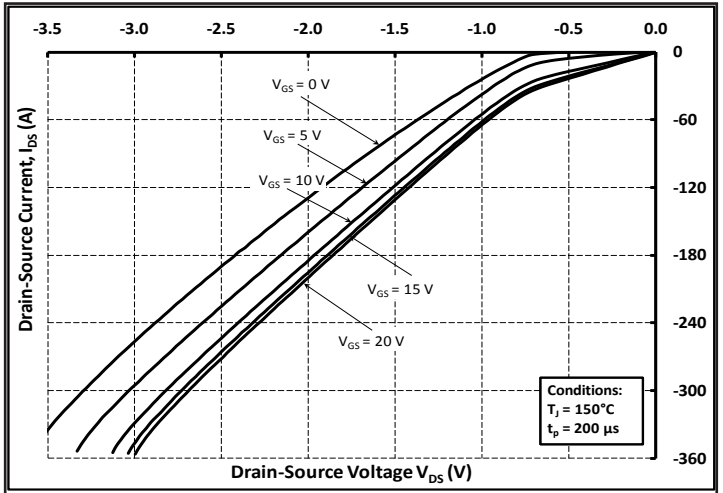

Figure 14. 3<sup>rd</sup> Quadrant Characteristic at 150 °C

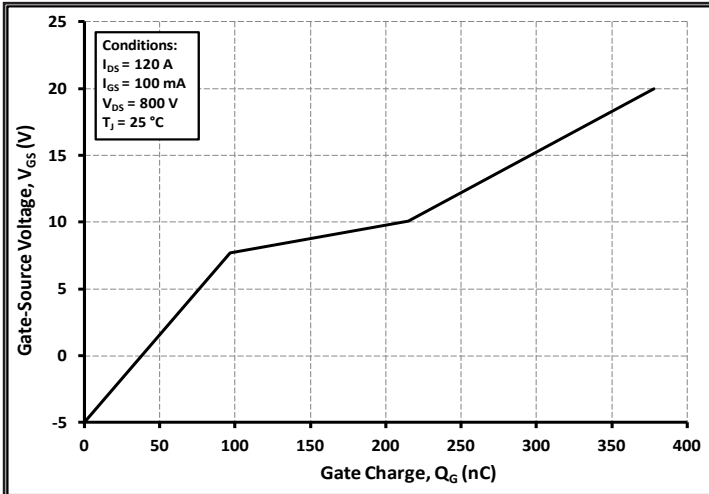

Figure 15. Gate Charge Characteristics

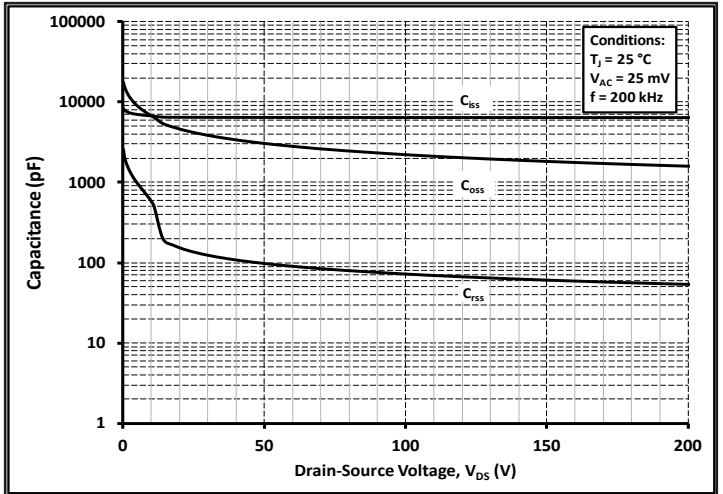

Figure 16. Capacitances vs. Drain-Source Voltage (0 - 200 V)

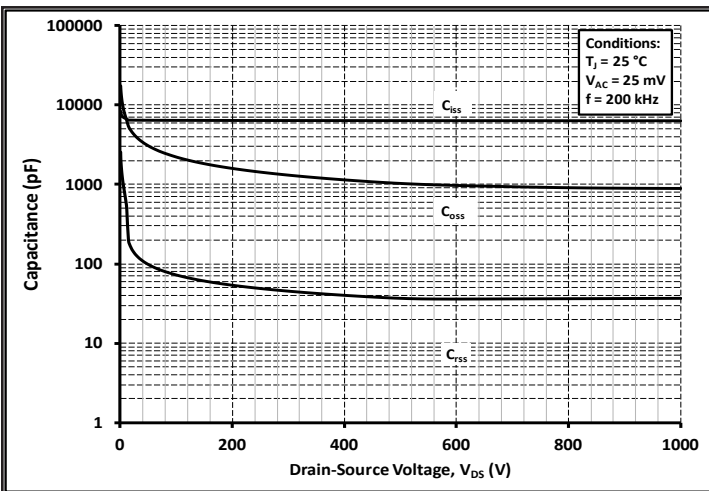

Figure 17. Capacitances vs. Drain-Source Voltage (0 - 1 kV)

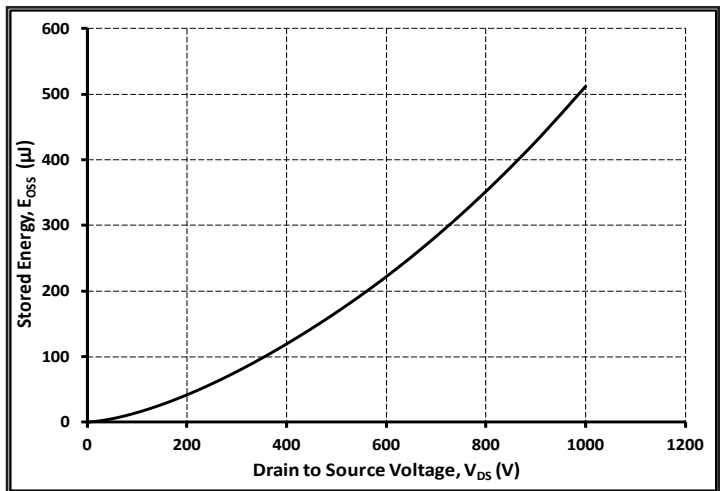

Figure 18. Output Capacitor Stored Energy

## Typical Performance

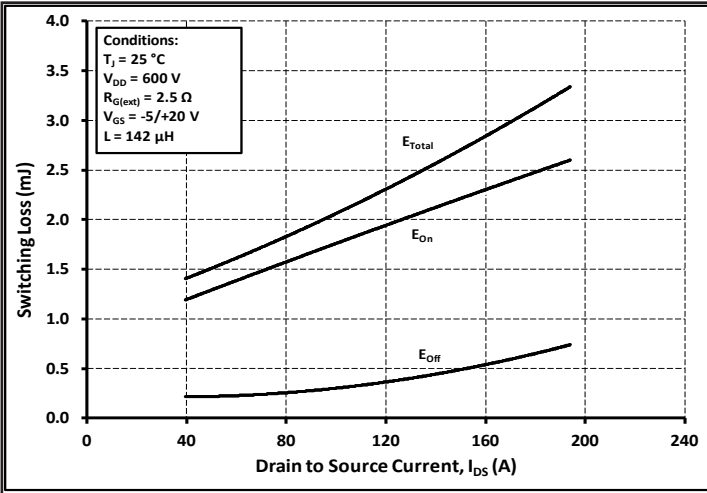

Figure 19. Inductive Switching Energy vs. Drain Current For  $V_{DS} = 600\text{ V}$ ,  $R_G = 2.5\text{ }\Omega$

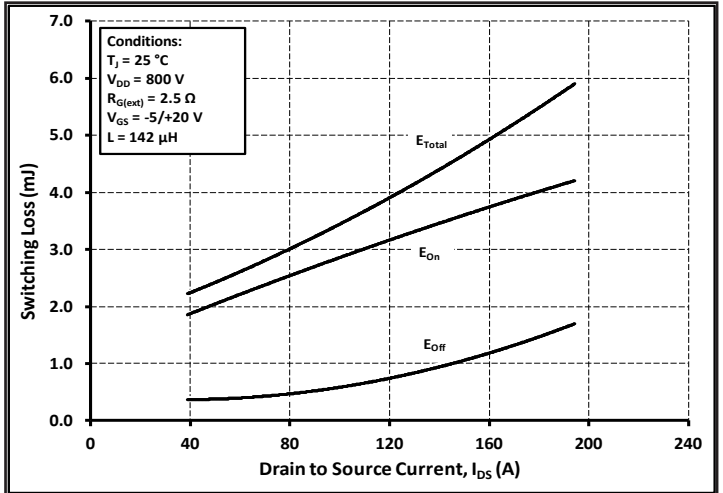

Figure 20. Inductive Switching Energy vs. Drain Current For  $V_{DS} = 800\text{ V}$ ,  $R_G = 2.5\text{ }\Omega$

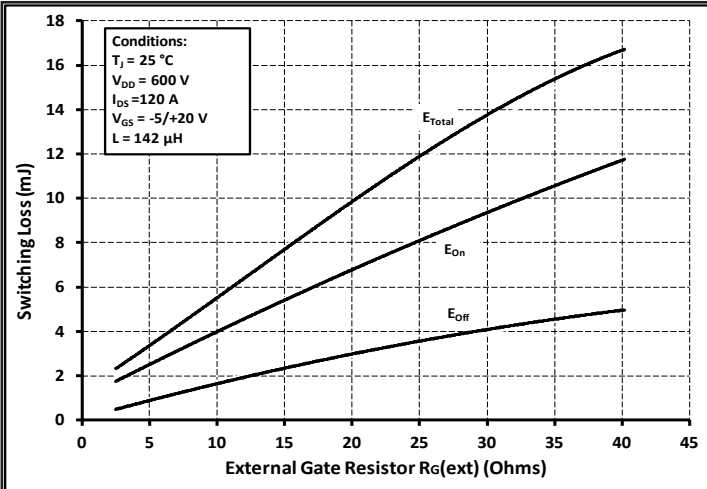

Figure 21. Inductive Switching Energy vs.  $R_{G(\text{ext})}$

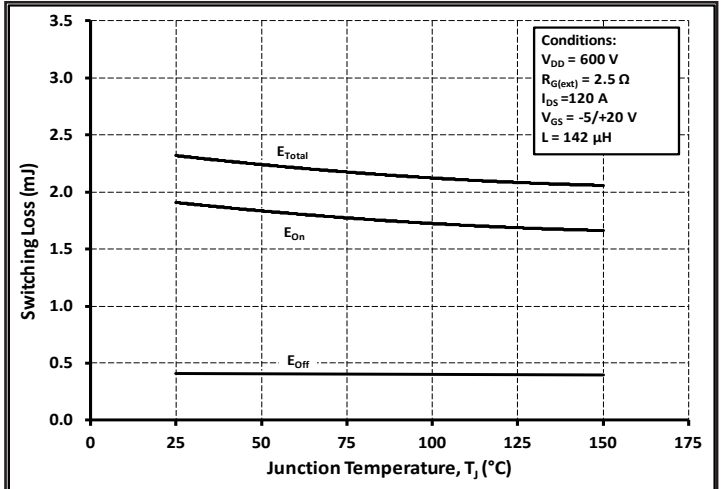

Figure 22. Inductive Switching Energy vs. Temperature

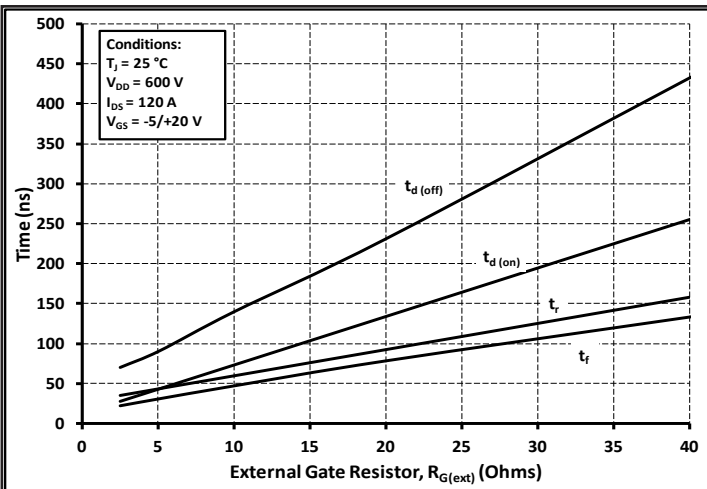

Figure 23. Timing vs.  $R_{G(\text{ext})}$

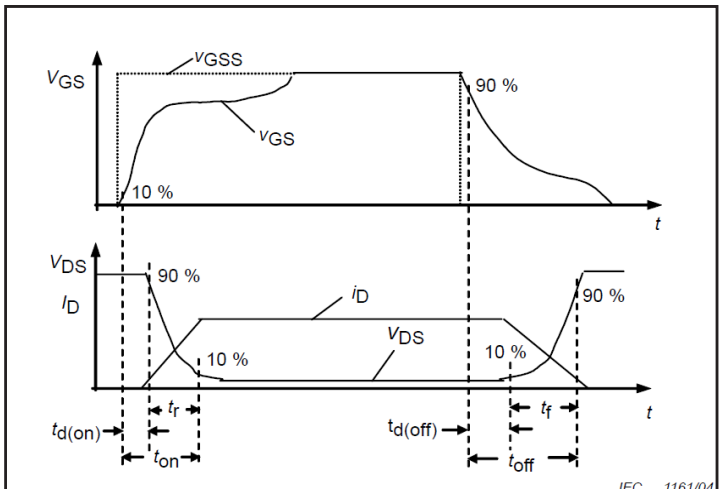

Figure 24. Resistive Switching Time Description

IEC 1161/04

# Typical Performance

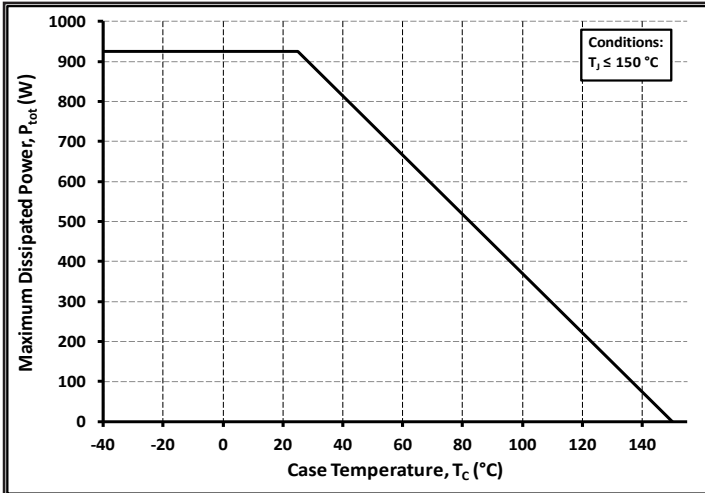

Figure 25. Maximum Power Dissipation (MOSFET) Derating vs. Case Temperature

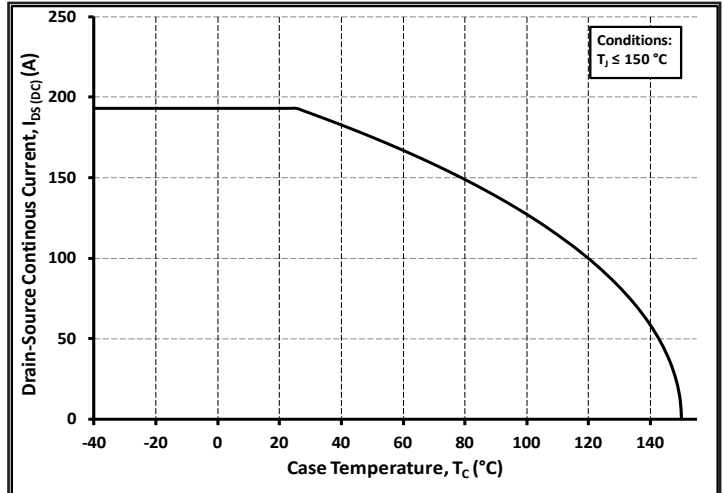

Figure 26. Continuous Drain Current (MOSFET) Derating vs. Case Temperature

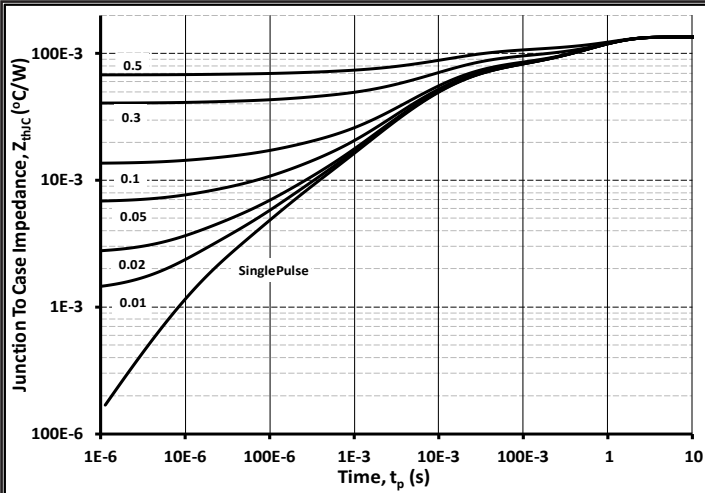

Figure 27. MOSFET Junction to Case Thermal Impedance

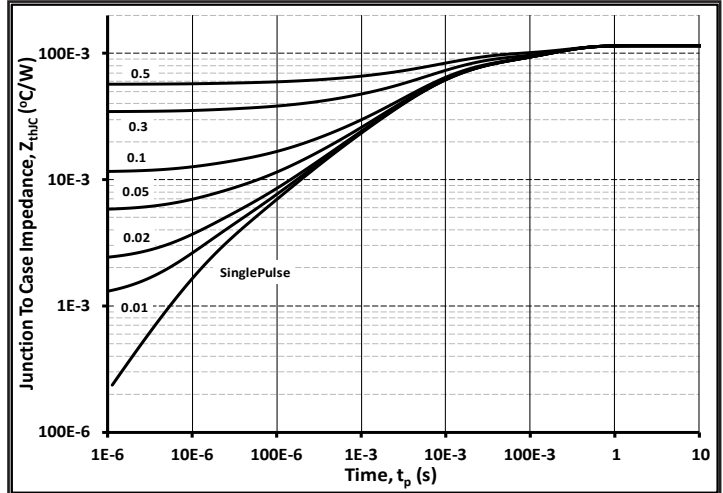

Figure 28. Diode Junction to Case Thermal Impedance

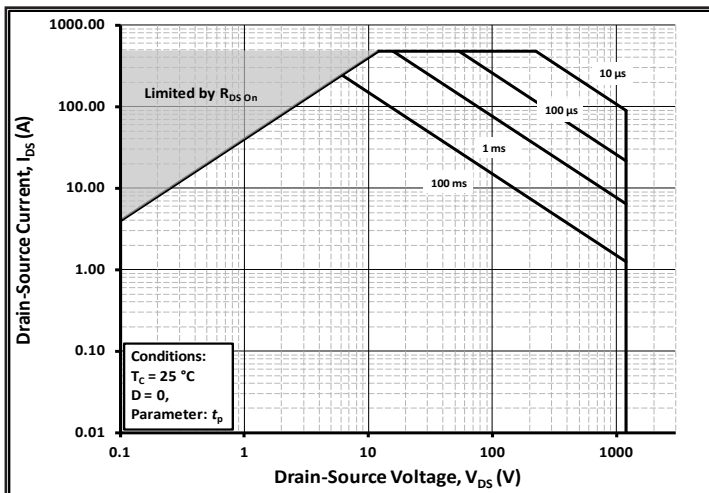
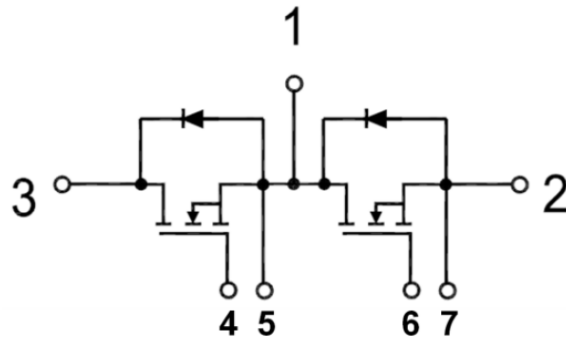
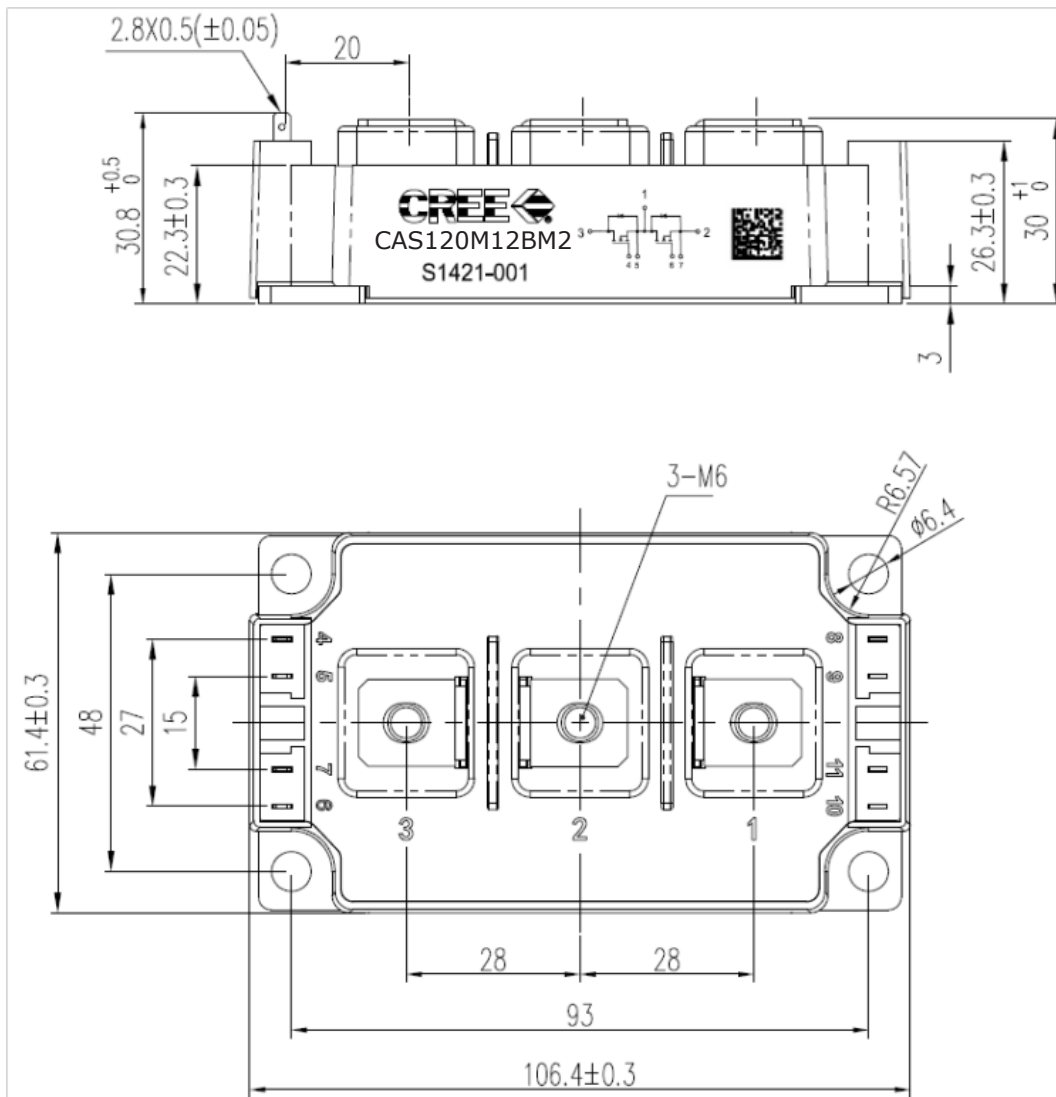

Figure 29. Maximum Power Dissipation (MOSFET) Derating vs. Case Temperature

**Schematic**



**Package Dimensions (mm)**







## Notes

---

- **RoHS Compliance**

The levels of RoHS restricted materials in this product are below the maximum concentration values (also referred to as the threshold limits) permitted for such substances, or are used in an exempted application, in accordance with EU Directive 2011/65/EC (RoHS2), as implemented January 2, 2013. RoHS Declarations for this product can be obtained from your Cree representative or from the Product Documentation sections of [www.cree.com](http://www.cree.com).

- **REACH Compliance**

REACH substances of high concern (SVHCs) information is available for this product. Since the European Chemical Agency (ECHA) has published notice of their intent to frequently revise the SVHC listing for the foreseeable future, please contact a Cree representative to insure you get the most up-to-date REACH SVHC Declaration. REACH banned substance information (REACH Article 67) is also available upon request.

- This product has not been designed or tested for use in, and is not intended for use in, applications implanted into the human body nor in applications in which failure of the product could lead to death, personal injury or property damage, including but not limited to equipment used in the operation of nuclear facilities, life-support machines, cardiac defibrillators or similar emergency medical equipment, aircraft navigation or communication or control systems, air traffic control systems.

### Module Application Note:

---

The SiC MOSFET module switches at speeds beyond what is customarily associated with IGBT based modules. Therefore, special precautions are required to realize the best performance. The interconnection between the gate driver and module housing needs to be as short as possible. This will afford the best switching time and avoid the potential for device oscillation. Also, great care is required to insure minimum inductance between the module and link capacitors to avoid excessive  $V_{DS}$  overshoots.

Please Refer to application note: Design Considerations when using Cree SiC Modules Part 1 and Part 2. [CPWR-AN12, CPWR-AN13]

# Mouser Electronics

Authorized Distributor

Click to View Pricing, Inventory, Delivery & Lifecycle Information:

[Cree, Inc.:](#)

[CAS120M12BM2](#)